

GB

Nr. B 052

GB

# Destroyer Siren

Warship siren "Clear decks for action". In rapid intervals sounds a shortly swelling tone: Uiiiit... Uiiiit... Power: 3...15 W, depending on the operating voltage. For 6...12 Volt. For loudspeaker connection 8 Ohm.

**Tin-plated board!**

deutsch / español / français / english /  
nederlands / portugues / suomi / greek

Fitting case:  
Kemo G027

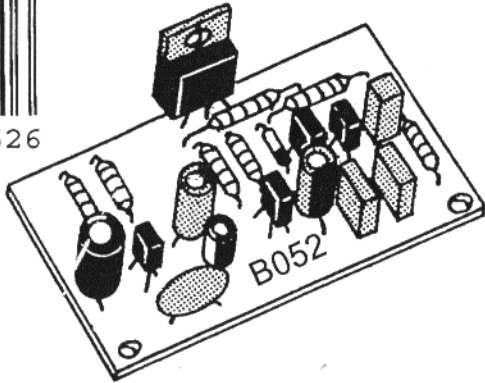
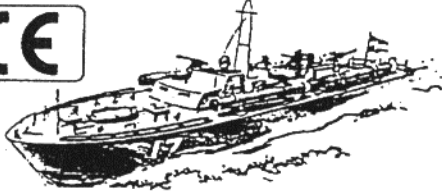

16 **Kemo Germany # 10-192**

D

Nr. B 052 040 106-9

D

# Zerstörer-Sirene

Kriegsschiff-Sirene "Klar Schiff zum Gefecht". In schnellen Abständen ertönt ein kurz aufschwellender Ton: Uiiiit... Uiiiit... Leistung: 3...15 W, je nach Betriebsspannung. Für 6...12 Volt. Für Lautsprecheranschluß 8 Ohm.

**Platine verzinnt!**

deutsch / español / français / english /  
nederlands / portugues / suomi / greek

Passendes Gehäuse:  
Kemo G027

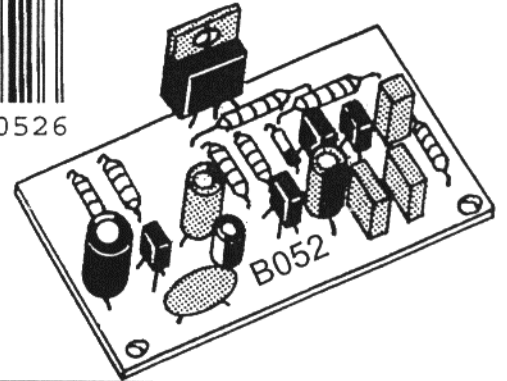
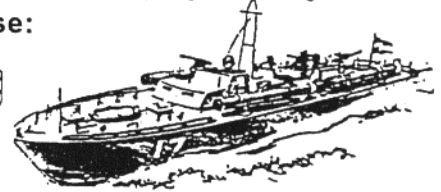
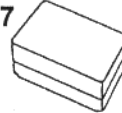

**Kemo Germany # 10-192**

1

NL / De sirene neemt, afhankelijk van de voedingsspanning een stroom op van 1...2 amp. Bij voedingsspanningen hoger dan 6 volt moet de transistor T5 gekoeld worden. Men benodigt een koelplaat met de afmetingen: ong. 50 x 50 x 3 mm. Let er vooral op, dat de transistoren op de juiste manier ingebouwd worden!

P / A sirene requiere dependendo da tensão de alimentação uma corrente de 1 a 2 Amperes. Com tensões de alimentação de mais de 6 V é necessário arrefecer o transistor T5. É necessário montar uma placa de arrefecimento de 50 x 50 x 3 mm. Tenha atenção aos terminais dos transístores, monte-os correctamente!

SF

Nr. B 052

SF

# Hävittäjä-sireeni

Sotalaivasireeni "valmistautukaa taisteluun". Nopeassa tahdissa kuuluu lyhyt "paisuva" ääni: Uiiiit... Uiiiit... Teho: 3...15W, riippuen käyttöjännitteestä. 6...12V jännitteelle. 8 Ohm kaiuttimelle.

**Piirilevy tinattu!**

deutsch / español / français / english /  
nederlands / portugues / suomi / greek

Sopiva kotelo:  
Kemo G027

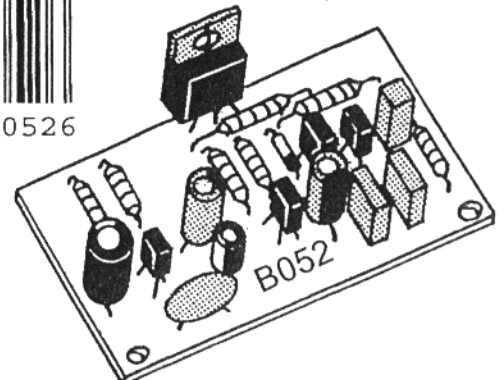
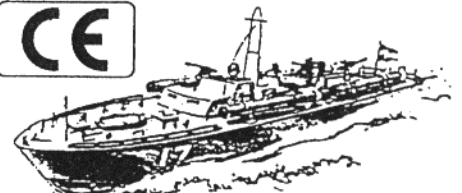
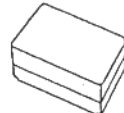

**Kemo Germany # 10-192**

3

NL

Nr. B 052

NL

## Torpedojager-Sirene

Oorlogsschip-sirene "Maak schip gereed voor gevecht". Er weerklint en snel pulserende kort aanzwellende toon: Uiiit... Uiiit... Voedingsspanning: 6...12 Volt. Vermogen 3...15 Watt. Voor 8 ohm luidsprekers.

**Printplaat vertind!**

deutsch / español / français / english /  
nederlands / portugês / suomi / greek

Passend huis:  
Kemo G027

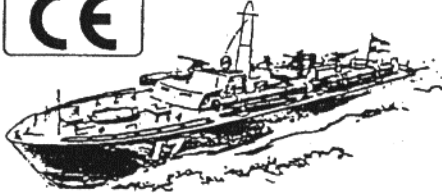

B052



4024028010526

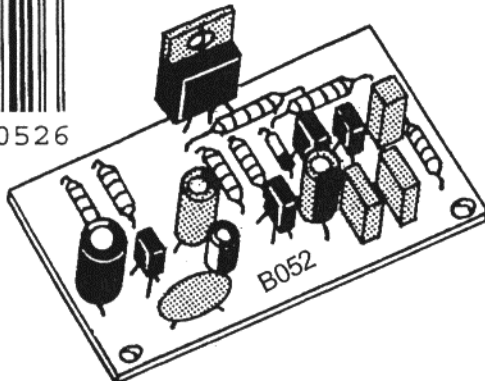

2 **Kemo Germany # 10-192**

15

F

Nr. B 052

F

## Sirène de torpilleur

Sirène de bateau de combat: "Paré pour le combat!"  
Un son court et ronflant retentit à espaces rapprochés: Uiiit... Uiiit... Puissance: 3...15 watts, selon la tension de service. Tension: 6...12 volts. Pour hauts-parleurs de 8 ohms.

**Platine étamée!**

deutsch / español / français / english /  
nederlands / portugês / suomi / greek

Boîtier  
recommandé:  
Kemo G027

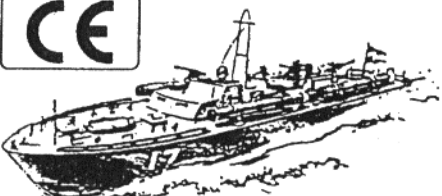

B052



4024028010526

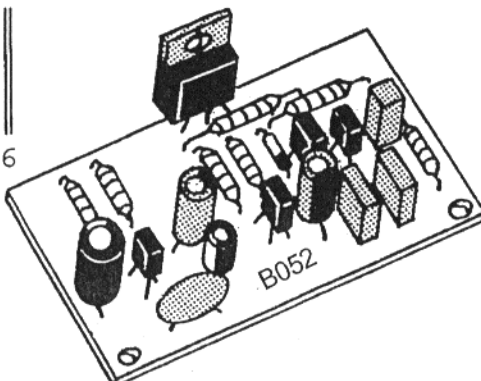

4 **Kemo Germany # 10-192**

SF / Sireeni tarvitsee käyttöjännitteestä riipuen 1...2A virtaa. Yli 6V käyttöjännitteellä täytyy transistori T5 jäähdyttää. Tarvitsee n. 50 x 50 x 3 mm jäähdytyslevyn. Ota huomioon että transistorit tulee oikein asennettua!

F / Cette sirène nécessite selon la tension de service un courant de 1...2 ampères. En cas de tension de service supérieure à 6 volts, il faut refroidir le transistor T5. Il faut un dissipateur d'env. 50 x 50 x 3 mm. Veiller à ce que les transistors soient montés correctement!

GB / The siren requires depending on the operating voltage 1...2 Ampere. With operating voltages of more than 6V, it is necessary to cool the transistor T5. It will be necessary to fit a cooling plate of approx. 50 x 50 x 3 mm. Please take care to mount correctly the transistors!

13

D / Die Sirene benötigt je nach Betriebsspannung 1...2 Ampere Strom. Bei Betriebsspannungen von über 6V muß der Transistor T5 gekühlt werden. Es ist ein Kühlblech von ca. 50 x50 x3 mm notwendig. Bitte achten Sie darauf, daß die Transistoren richtig eingebaut werden!

E/ La sirena necesita 1...2 amperio de corriente dependiendo de la tensión de servicio. Con tensiones de servicio de más de 6V, es necesario refrigerar el transistor T5. Se necesita una chapa refrigerante aprox. 50 x 50 x 3 mm. ¡Por favor, observe Vd. que los transistores se instalan de manera correcta!

**E** **Nr. B 052** **E**

### Sirena de destructor

Sirena de buque de guerra "Cubierta clara a la acción". En rápidos intervalos un sonido ascendente breve resuena: Uiiit... Uiiit... Potencia: 3...15 W dependiendo de la tensión de servicio. Para 6...12 voltio. Para conexión de altavoz de 8 ohmio.

**¡Placa estañada!**

deutsch / español / français / english /  
nederlands / portugês / suomi / greek

Caja pertinente:  
Kemo G027

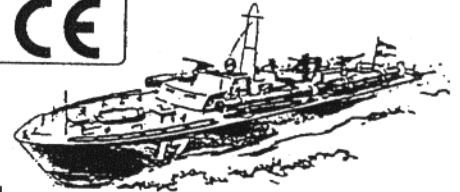
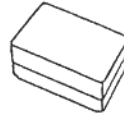

4024028010526

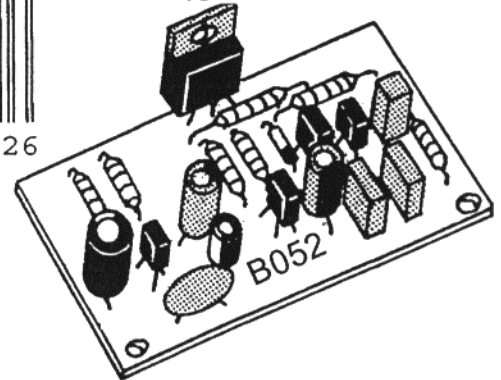

**Kemo Germany # 10-192**

**GR** **Nr. B 052** **GR**

### ΣΕΙΡΗΝΑ ΑΝΤΙΤΟΡΠΙΛΙΚΟΥ

Κατασκευή σειρήνας διαπεραστικού ηχου, ομοιο με το ηχητικο σημα πολεμικου "ετοιμο για τη μαχη". Τεχνικα χαρακτηριστικα: Ταση λειτουργιας 6 εως 12 V. Ισχυς 3 περιπου εως 15 W. Μεγαφωνο 8 Ω.

**Tin-plated board!**

deutsch / español / français / english /  
nederlands / portugês / suomi / greek

Fitting case:  
Kemo G027

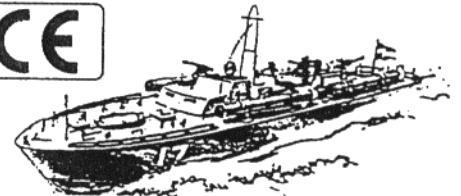

4024028010526

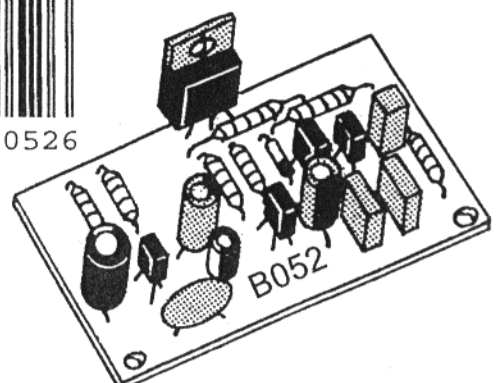

**Kemo Germany # 10-192**

# Sirene de barco

Sirene de barco "Alerta para acção". Em intervalos rápidos soa num curto intervalo: Uiiit... Uiiit... Potência: 3 a 15W, dependendo da tensão de funcionamento. Para 6 a 12 volts. Para altifalantes de 8 Ohm.

Placa estanhada!

deutsch / español / français / english /  
nederlands / portuguese / suomi / greek

Caixa adequado:  
Kemo G027

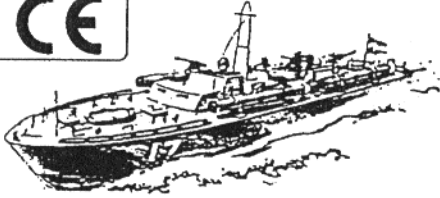

4024028010526

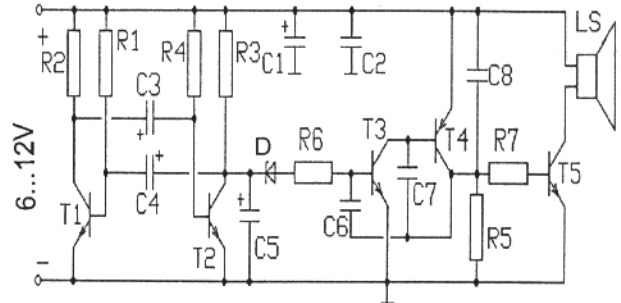
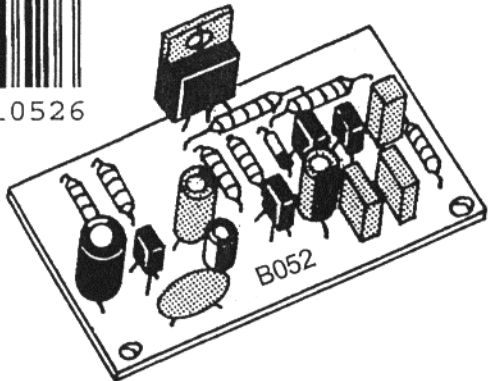

B052/10-192

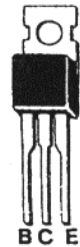
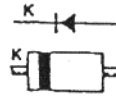

## 6 Kemo Germany # 10-192

- D / Lautsprecher
- E / Altavoz
- F / Haut-parleur
- GB / Loudspeaker
- GR / Loudspeaker
- NL / Luidspreker
- P / Altifalante
- SF / Kaiutin

- 6...12V
- D / Batterie
- E / batería
- F / batterie
- GB / battery
- GR / battery
- NL / batterij
- P / bateria
- SF / paristo

